

Instruction Manual/Owner's Manual

# **STIHL** **041 FARM BOSS**

Occasional User Saw

8/83



# **STIHL**<sup>®</sup>

**Warning!**  
For safe operation follow all safety  
precautions in owner's manual —  
improper use can cause  
serious injury!

## Important Safety Precautions

1. Do not operate a chain saw when you are fatigued.
2. Use safety footwear, snug-fitting clothing, and eye, hearing and head protection devices.
3. Use caution when handling fuel. Move the chain saw at least 10 feet (3 m) from the fueling point before starting the engine.
4. Do not allow other persons to be near the chain saw when starting or cutting with the chain saw. Keep bystanders and animals out of the work area.
5. Do not start cutting until you have a clear work area, secure footing, and a planned retreat path from the falling tree.
6. Hold the chain saw firmly with both hands, the right hand on the rear handle and the left hand on the front handle, when the engine is running. Use a firm grip with thumbs and fingers encircling the chain saw handles.
7. Keep all parts of your body away from the saw chain when the engine is running.
8. Before you start the engine, make sure the saw chain is not contacting anything.
9. Carry the chain saw with the engine stopped, the guide bar and saw chain to the rear, and the muffler away from your body.
10. Do not operate a chain saw that is damaged, improperly adjusted, or is not completely and securely assembled. Be sure that the saw chain stops moving when the throttle trigger is released.
11. Shut off the engine before setting it down.
12. Use extreme caution when cutting small size brush and saplings because slender material may catch the saw chain and be whipped toward you or pull you off balance.
13. When cutting a limb that is under tension be alert for spring back so that you will not be struck when the tension in the wood fibers is released.

continued on the back inside cover →

# STIHL 041 Farm Boss

## Congratulations!

You are the owner of a precision-manufactured STIHL chain saw designed to give you long and dependable service. To receive maximum performance and satisfaction from your STIHL chain saw, it is important that you read and understand the maintenance and safety precautions before using your saw. Contact your STIHL Dealer or the STIHL Distributor for your area if you do not understand any of the instructions or warnings in this Manual.

This Manual contains warnings regarding your saw, operating and safety instructions for all STIHL 041 Farm Boss power saws.

## Warning!

Because a chain saw is a high-speed wood-cutting tool, some special safety precautions must be observed as with any other power saw to reduce the risk of personal accidents. Careless or improper use may cause serious or even fatal injury.

It is important that you fully understand the contents of this Manual and that you allow only persons who understand this Manual to operate your chain saw.

Pay special attention to the cutting techniques and safety precautions outlined on pages 4 to 19.

STIHL's philosophy is to continually improve all of its products. As a result, engineering changes and improvements are made from time-to-time. Written notices relating to such changes are sent to STIHL Dealers. If the operating characteristics or the appearance of your saw differs from those described in this Manual, please contact your local STIHL Dealer for updated information and assistance.

## Instruction Manual/Owner's Manual, Sharpening and Maintenance of Saw Chains

### Contents

Parts of the Chain Saw	2
Safety Precautions	4
– The Operator	4
– The Saw	6
– The Use of the Saw	6
– Maintaining and Storing the Saw	19
Fuel and chain lubricating oil	20
Mounting the bar and chain	20
Starting	22
Cutting attachment	24
Oil quantity control	26
Air filter	26
Carburetor	27
Rewind starter	28
Replacing the chain sprocket	30
Maintenance Chart	31
Specifications	32
Sharpening and maintenance of saw chains	33

**STIHL**®

Andreas Stihl  
Postfach 1760

D-7050 Waiblingen

## Parts of the Chain Saw

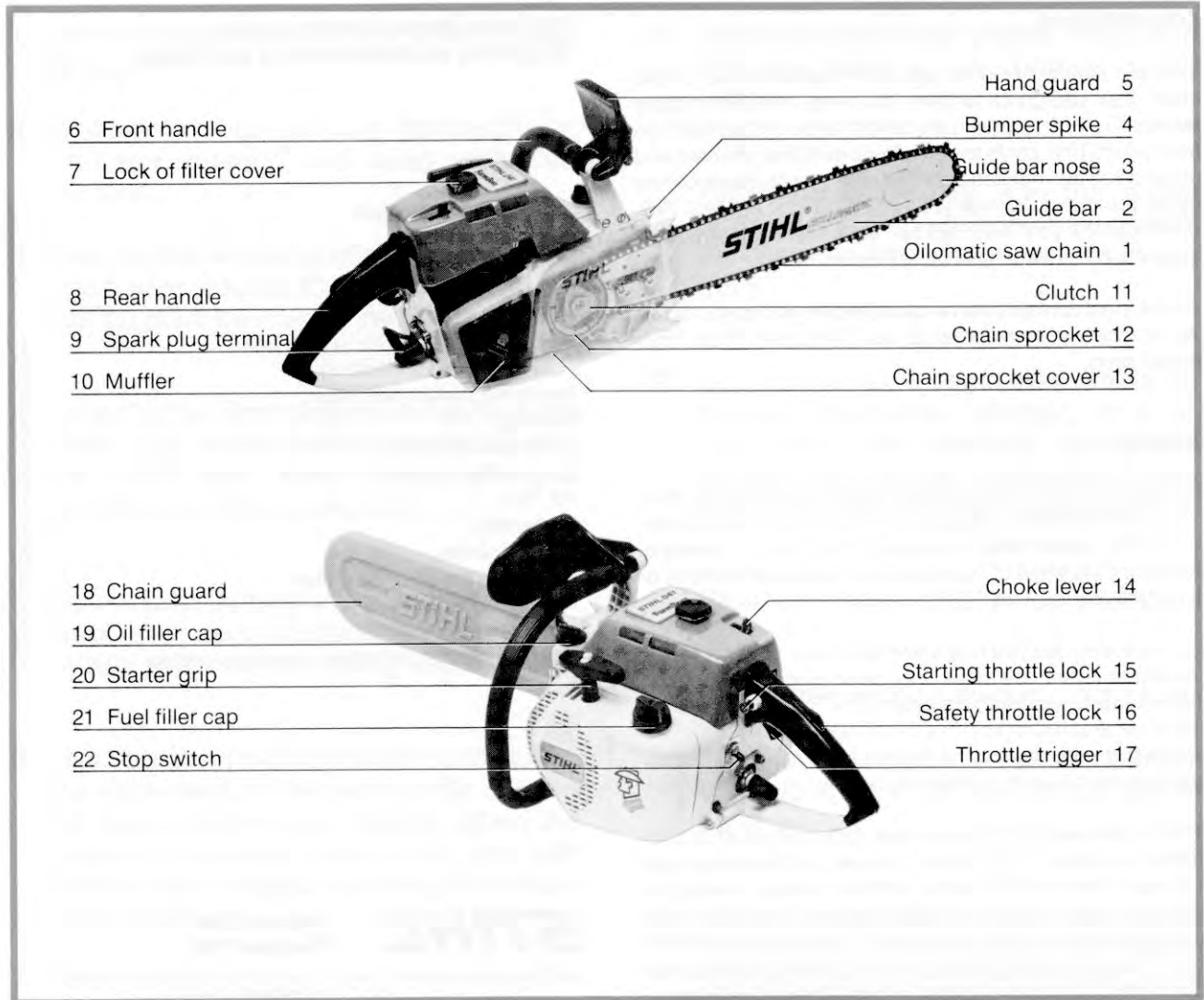

## Definitions

1. **Oilomatic saw chain.** A loop consisting of cutters, tie straps and drive links.
  2. **Guide bar.** Supports and guides the saw chain.
  3. **Guide bar nose.** The exposed part of the guide bar.
  4. **Bumper spike.** Toothed stop for holding saw steady against wood.
  5. **Hand guard.** Provides protection against projecting branches and helps prevent the left hand from touching the chain if it slips off the handle bar.
  6. **Front handle.** Handle bar for the left hand at front of saw.
  7. **Lock of filter cover.** For removing filter cover, permits filter to be cleaned.
  8. **Rear handle.** The support handle for the right hand, located at or toward the rear of the saw.
  9. **Spark plug terminal.** Connects the spark plug with the ignition wire.
  10. **Muffler.** Attenuates exhaust noises and diverts exhaust gases in required direction.
  11. **Clutch.** Couples engine to chain sprocket when engine is accelerated beyond idle speed.
  12. **Chain sprocket.** The toothed wheel that drives the saw chain.
  13. **Chain sprocket cover.** Covers the clutch and the sprocket.
  14. **Choke lever.** Eases engine starting by enriching mixture.
  15. **Starting throttle lock.** Keeps the throttle partially open during starting.
  16. **Safety throttle lock.** Must be depressed before activating the throttle trigger.
  17. **Throttle trigger.** Controls the speed of the engine.
  18. **Chain guard (scabbard.)** Protects the operator from touching the chain.
  19. **Oil filler cap.** For closing the oil tank.
  20. **Starter grip.** The grip of the pull starter, which is the device to start the engine.
  21. **Fuel filler cap.** For closing the fuel tank.
  22. **Stop switch.** Switches the engine's ignition system off and stops the running of the engine.
- Chain catching bolt.** Catches a broken chain and guides it inside the chain sprocket cover (not illustrated).

## Safety Precautions



The use of any chain saw may be hazardous. The saw chain has large, sharp cutters. If the cutters contact your flesh, they will cut you, even if the chain is not moving. At full throttle, the chain speed can reach 45 mph (20 m/s). It is important that you read, fully understand and observe the following safety precautions and warnings. Read the owner's manual **and** the safety instructions periodically. Pay special attention to the section on reactive forces, pages 10 to 13.

### Warning!

Reactive forces, including kickback, can be dangerous. Careless or improper use of any chain saw may cause serious or fatal injury.

All safety precautions that are generally observed when working with an axe or a hand saw also apply to the operation of chain saws. However, because a chain saw is a highspeed, fast cutting power tool, special safety precautions must be observed to reduce the risk of personal accidents.

Have your STIHL dealer show you how to operate your chain saw. Observe all applicable local safety regulations, standards and ordinances.

### Warning!

Minors should never be allowed to use a chain saw.



Bystanders, especially children and animals should not be allowed in the area where a chain saw is in use (ill. 1). Never let the saw run unattended. Store it in a locked place away from children and empty the fuel tank before storing for longer than a few days.

Do not lend your chain saw without the Owner's Manual. Be sure that anyone using your saw understands the information contained in this Manual.

These safety precautions and warnings apply to the use of all STIHL chain saws. Different models may have different parts and controls. See the appropriate section of your Owner's Manual for a description of the controls and function of the parts of your model saw.

Safe use of a chain saw involves

1. the operator
2. the saw
3. the use of the saw.

## THE OPERATOR

### Physical Condition

You must be in good physical condition and mental health and not under the influence of any substance (drugs, alcohol), which might impair vision, dexterity or judgment.

Do not operate a chain saw when you are fatigued (ill. 2). Be alert – If you get tired while operating your chain saw, take a break, tiredness may result in loss of control. Working with any chain saw can be strenuous. If you have any condition that might be aggravated by strenuous work, check with your doctor before operating a chain saw.

### Warning!

Prolonged use of chain saws (or other machines) exposing the operator to vibrations may produce Whitefinger disease (Raynaud's phenomenon). This phenomenon reduces the hand's ability to feel and regulate temperature, produces numbness and burning sensations and may cause nerve and circulation damage and tissue necrosis. Many STIHL models are available with an anti-vibration system designed to reduce engine vibration. An anti-vibration system is recommended for those using chain saws on a regular or sustained basis.

Heated handles help to reduce the risk of Whitefinger disease and are recommended for cold weather use. Most STIHL powerheads are available with heated handles.

Anti-vibration systems and heated handles do not guarantee that you will not sustain Whitefinger disease. Therefore continual and regular users should monitor closely the condition of their hands and fingers. If any of the above symptoms appear, seek medical advice immediately.

### Proper Clothing

Clothing must be sturdy and snug-fitting, but allow complete freedom of movement. Avoid loose-fitting jackets, scarfs, neckties, jewelry, flared or cuffed pants, or anything that could become entangled with the saw or brush. Wear overalls or jeans with a reinforced cutting resistant insert (ill. 3).

Protect your hands with gloves when handling saw and saw chain. Heavy-duty, nonslip gloves improve your grip and protect your hands.



Good footing is most important in chain saw work. Wear sturdy boots with nonslip soles. Steel-toed safety boots are recommended.

Proper eye protection is a must. Non-fogging, vented goggles or a face screen is recommended. Their use reduces the risk of eye injury.

Wear an approved safety hard hat to protect your head. Chain saw noise may damage your hearing. Always wear sound barriers (ear plugs or ear muffers) to protect your hearing.

Continual and regular users should have their hearing checked regularly.

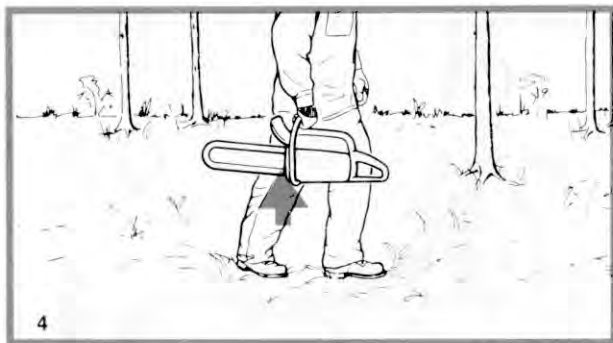

## THE SAW

Parts of the chain saw; illustrations and definitions of the parts see pages 2 and 3!

### Warning!

Never modify a chain saw in any way. Only attachments supplied by STIHL or expressly approved by STIHL for use with the specific STIHL saw models are authorized. Although certain unauthorized attachments are useable with the STIHL powerhead, their use may, in fact, be extremely dangerous.

## THE USE OF THE SAW

### Transporting the chain saw

#### Warning!

Always stop the engine before putting a chain saw down or carrying it. Carrying a chain saw with the engine running is extremely dangerous. Accidental acceleration of the engine can cause the chain to rotate. Avoid touching the hot muffler.

must be stopped and the saw must be in the proper position. Grip the front handle and place the muffler at the side away from the body (ill. 4).

The chain guard (scabbard) should be over the chain and the guide bar which should point backwards. When carrying your saw the bar should be behind you (ill. 4).

**By vehicle:** When transporting in a vehicle, keep chain and bar covered with the chain guard. Properly secure your saw to prevent turnover, fuel spillage and damage to the saw.

### Preparation for the use of the saw

Take off the chain guard and inspect for safety in operation. For assembly please follow the procedure described at the appropriate section "Mounting the Bar and Chain" of your Owner's Manual.

STIHL-Oilomatic chain, guide bar and sprocket must match each other.

If the guide bar or chain is replaced, it must be with a bar or chain of the same type. Replacement with another type of guide bar or chain will seriously increase the chances of operator injury due to the contact of the moving chain with the operator during rotational kickback.

#### Warning!

Proper tension of the chain is extremely important. In order to avoid false setting the tensioning procedure must be followed as described in your Manual. Make always sure the hexagonal nut(s) for the sprocket cover is (are) tightened securely after tensioning the chain. Check chain tension once more after having tightened the nuts and thereafter at regular intervals (whenever the saw is shut off). If the chain becomes loose while cutting, shut off the engine and then tighten. Never try to tighten the chain while the engine is running!

**6** **By hand:** When carrying your saw by hand, the engine



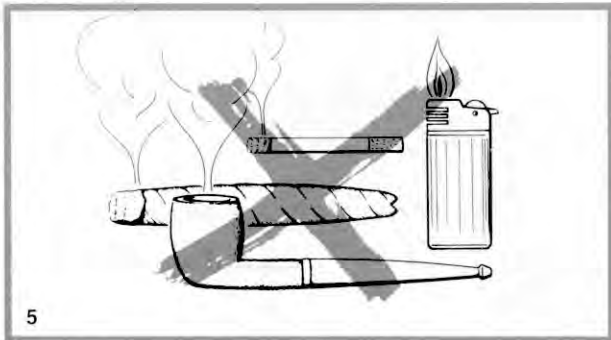

### Fueling

Your STIHL chain saw uses an oil-gasoline mixture for fuel (see chapter "Fuel" of your Owner's Manual).

### Warning!

Gasoline is an extremely flammable fuel. Use extreme caution when handling gasoline or fuel mix. Do not smoke or bring any fire or flame near the fuel (ill. 5).

### Fueling Instructions

Fuel your chain saw in well-ventilated areas, outdoors only.

Always shut off the engine and allow it to cool before refueling. Relieve fuel tank pressure by loosening fuel cap slowly.

Select bare ground for fueling and move at least 10 feet (3 m) from fueling spot before starting the engine.

Wipe off any spilled fuel before starting your saw and check for leakage.

Check for fuel leakage while refueling and during operation. If fuel or oil leakage is found, do not start or run the engine until leak is fixed and spilled fuel has been wiped away.



### Starting

### Warning!

Your chain saw is a one-person saw. Do not allow other persons to be near the chain saw. Start and operate your saw without assistance.

For safe and specific starting instructions, see the appropriate section of the Owner's Manual.

Do not drop start. This method is very dangerous because you may lose control of the saw (ill. 6).

Place the chain saw on firm ground or other solid surface in an open area. Maintain a good balance and secure footing.

Be absolutely sure that guide bar and chain are clear of you and all other obstructions and objects, including the ground: because when the engine starts at starting-throttle, engine speed will be fast enough for the clutch to engage sprocket and turn the chain, which may cause kickback to occur.

Engage the chain brake when starting a Quickstop model (see chapter "Chain Brake" in your Owner's Manual).

Never attempt to start the saw when the guide bar is in a cut or kerf.

When you pull the starter grip, don't wrap the starter rope around your hands. Do not allow the grip to snap back, but guide the starter rope slowly back to permit the rope to rewind properly. Failure to follow this procedure may result in injury to hand or fingers and may damage the starter mechanism.

### Important adjustments

**Warning!** At correct idle speed, chain should not turn. For directions to adjust idle speed, see the appropriate section of this Owner's Manual.

Do not use a saw with incorrect idle speed adjustment. Adjust the idle speed your-self according to the appropriate section of this manual.

Have your STIHL Dealer check your saw and make proper adjustments or repairs.

After adjusting a chain start the saw, let the engine run for a while, then switch engine off and recheck chain tension. Proper chain tension is very important at all times.

### Working Conditions

Operate your chain saw only outdoors in a ventilated area. Operate the saw under good visibility and daylight conditions only.

**Warning!** Take extreme care in wet and freezing weather (rain, snow, ice). Put off the work when the weather is windy, stormy or rainfall is heavy. Clear the area where you are working.

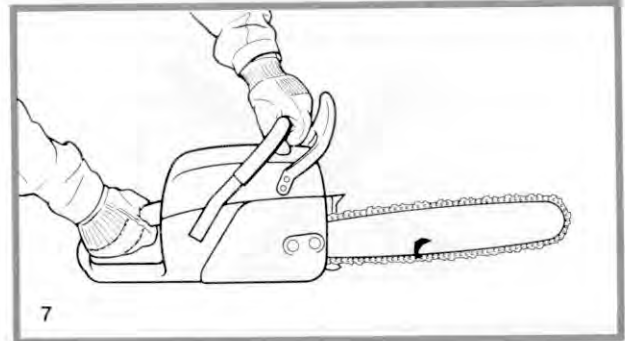

**Warning!** Avoid stumbling on obstacles such as stumps, roots or rocks and watch out for holes or ditches. Be extremely cautious when working on slopes or uneven ground. There is increased danger of slipping on freshly debarked logs.

### Cutting Instructions

**Grip:** Always hold the saw firmly with both hands when the engine is running. Place your left hand on front handle bar and your right hand on rear handle and throttle trigger. Left-handers should follow this instruction too.

Wrap your fingers tightly around the handles, keeping the handles cradled between your thumb and forefinger (ill. 7). With your hands in this position, you can best oppose and absorb the push, pull and kickback forces of your saw without having it slip out of your grip (see section of reactive forces). Make sure your chain saw handles and grip are in good condition and free of moisture, pitch, oil or grease.

**Warning!** Never use the saw with one hand. You cannot control reactive forces (see pages 10 to 13) and may lose control of the saw.

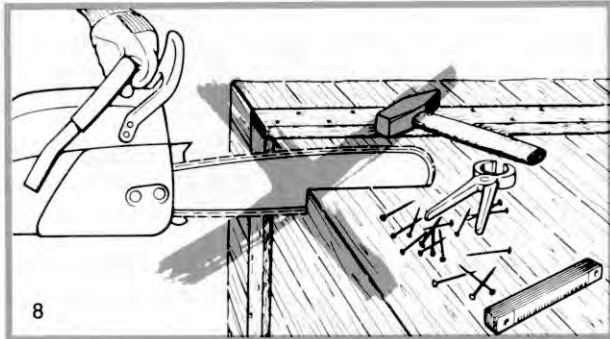

**Warning!** Do not operate your chain saw with starting throttle. Cutting with starting throttle does not permit the operator proper control of the saw or chain speed.

**Warning!** Never touch a rotating chain with your hand or any part of your body.

**Warning!**

Do not cut any material other than wood or wooden objects.

Use your chain saw for cutting only. It is not designed for prying or shoveling away limbs, roots or other objects.



When sawing, make sure that the saw chain does not touch any foreign materials such as rocks, nails and the like (ill. 8). Such objects may be flung off, damage the saw chain or cause the saw to kick back.

In order to keep control of your saw, always maintain a firm foothold. Never work on a ladder, in a tree or on any other insecure support. Never use the saw above shoulder height (ill. 9).



Position the chain saw in such a way that your body is clear of the cutting attachment whenever the engine is running. Stand to the left of cut while bucking (see ill. 10).

Don't put pressure on the saw when reaching the end of a cut. The pressure may cause the bar and rotating chain to pop out of the cut or kerf, go out of control and strike the operator or some other object. If the rotating chain strikes some other object a reactive force (see pages 10 to 13) may cause the chain to strike the operator.

## Reactive forces during the cut, including kickback

### Warning!

Reactive forces, that may occur during any cut are kickback, pushback and pull-in. Reactive forces can be dangerous! In any chain saw, the powerful force used to cut wood can be reversed (and work against the operator).

If the rotating chain is suddenly stopped by contact with any solid object like a log or branch or is pinched, the reactive forces instantly occur. These reactive forces may result in loss of control which may, in turn, cause serious or fatal injury. An understanding of the causes of these reactive forces may help you avoid loss of control.

The most common reactive forces are

- kickback,
- pushback,
- pull-in.

### Kickback:

Kickback occurs when the upper quadrant of the bar nose contacts a solid object in the wood or is pinched (ill. 11). The reaction of the cutting force of the chain causes a rotational force of the chain saw in the direction opposite to the chain movement, mainly in the plane of the bar. This may fling the bar in an uncontrolled arc mainly in the plane of the bar.

Under some circumstances the bar moves towards the operator who may suffer severe or fatal injury. It may also occur during limbing. It also occurs when the nose of the guide bar is pinched unexpectedly, unintentionally contacts solid material in the wood (ill. 12) or is incorrectly used to begin a plunge or boring cut.

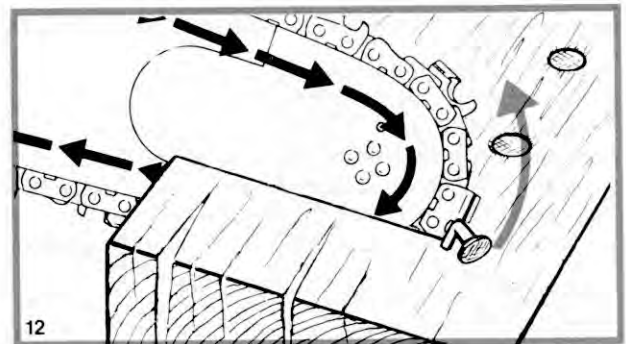
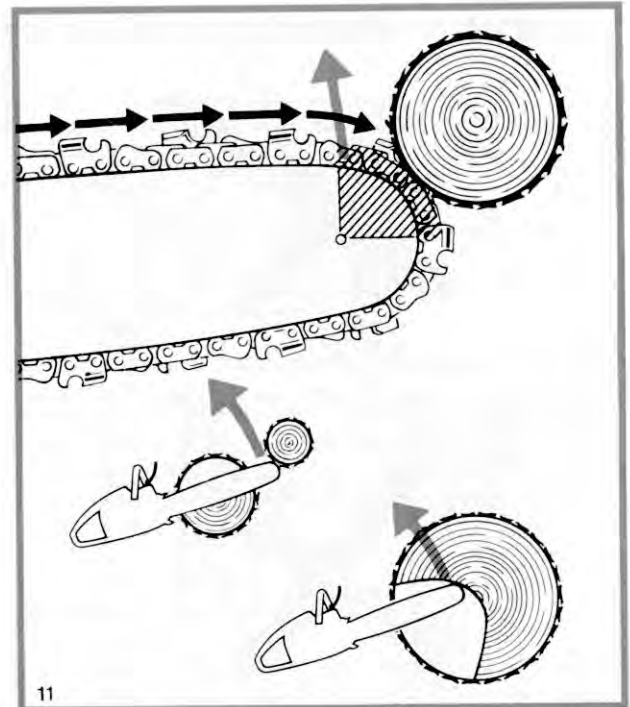

Many factors influence the occurrence and force of the kickback reaction. The type of bar and saw chain you use is a factor in the force of the kickback reaction.

**The speed of contact at which the cutter contacts the object.**

Kickback forces increase with the rate of impact.

**The contact angle between the nose of the bar and the foreign object** (see ill. 11).

Kickback is most pronounced in the upper quadrant of the bar nose.

Some **STIHL chain types** are designed to reduce kickback forces.

**The depth gauges:**

Improper lowering of the depth gauges also increases the chance of a kickback.

**The sharpening condition:**

**Warning!**

A dull or improperly sharpened chain may increase the risk of kickback. Always cut with a properly sharpened chain.

**Devices for reducing the risk of kickback injury**

STIHL has developed a chain stopping system to reduce the risk of injury in certain kickback situations. It is called a Quickstop.

The Quickstop is available as an option on most STIHL chain saws.

When a kickback occurs the guide bar may rotate around the front handle. If the cutting position is such that the

operator's left hand is gripping the front handle behind the hand guard, and if the left hand rotates around the front handle and contacts the front hand guard, which is the Quickstop activating lever, this contact will activate the Quickstop and stops the chain (see ill. 13).

The chain brake of some STIHL chain saws is additional self-activated by inertia. See appropriate chapter "Chain Brake" of your Owner's Manual.

Kickback tendency increases as the radius or size of the guide bar nose increases. STIHL has developed guide bars with small nose radius. These bars are designed to reduce the kickback tendency and are available as an option.

STIHL has developed chains whose configurations are designed to reduce kickback forces. These chains are available as an option.

**Warning!**

Chain saw kickback may cause serious or fatal injury. To reduce the risk of kickback injuries STIHL recommends that you equip your saw with a narrow nose bar, low profile chain or other chain designed to reduce kickback forces, and a STIHL Quickstop.

**Warning!**

No Quickstop or chain brake device prevents kickback. These devices are designed only to stop the chain, if activated, in certain kickback situations.

In order for the Quickstop to reduce the risk of kickback injury, it must be properly maintained and in good working order. In addition, there must be enough distance between the bar and the operator to ensure that the Quickstop has sufficient time to activate and stop the chain before potential contact with the operator.

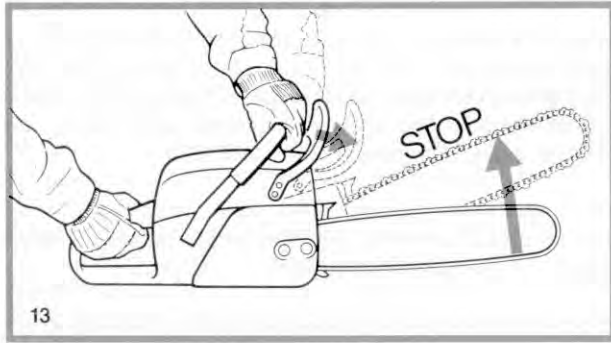

### Warning!

Even if your saw is equipped with a Quickstop, a narrow nose bar or reduced kickback chain, this does not guarantee that you will not be injured by kickback, and therefore always observe all safety precautions to avoid kickback situations.

### To avoid kickback

The best protection from personal injury that may result from kickback is to avoid kickback situations:

1. Hold the chain saw firmly with both hands and maintain a secure grip.
2. Be aware of the location of the guide bar nose at all times.
3. Never bring the nose of the guide bar in contact with any object. Do not cut limbs with the nose of the guide bar. Be especially careful with small, tough limbs, small size brush and saplings which may easily catch the chain.
4. Don't overreach.
5. Don't cut above shoulder height.

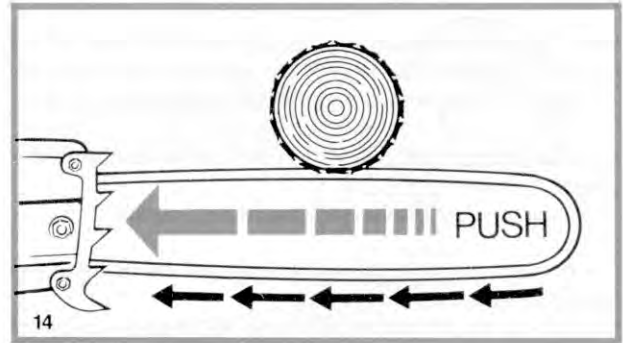

6. Begin cutting and continue at full throttle.
7. Cut only one log at a time.
8. Use extreme caution when re-entering a previous cut.
9. Do not attempt plunge cuts (see page 16) if you are not experienced with these cutting techniques.
10. Be alert for shifting of the log or other forces that may cause the cut to close and pinch the chain.
11. Maintain saw chain properly. Cut with a correctly sharpened, properly tensioned chain at all times.
12. Stand to the side of the cutting path of the chain saw.

### Pushback:

Pushback occurs when the chain on the top of the bar is suddenly stopped when it is pinched, caught or encounters a foreign object in the wood. The reaction of the chain drives the saw straight back toward the operator causing loss of saw control. Pushback frequently occurs when the top of the bar is used for cutting (see ill. 14).

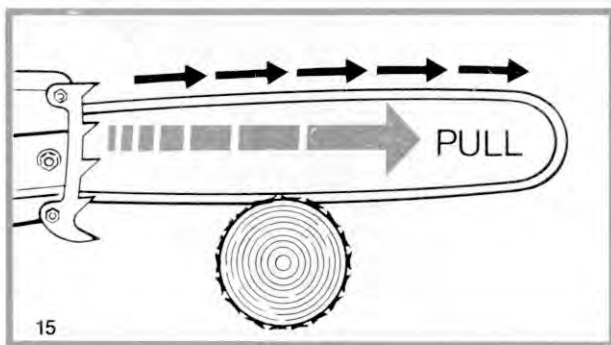

### To avoid pushback

1. Be alert to forces or situations that may cause material to pinch the top of the chain.
2. Do not cut more than one log at a time.
3. Do not twist the saw when withdrawing the bar from a plunge cut or under buck cut (figures 25 to 27 and 33, pages 16, 17 and 19), because the chain can pinch.

### Pull-in:

Pull-in occurs when the chain on the bottom of the bar is suddenly stopped. The chain on the bottom of the bar stops when it is pinched, caught or encounters a foreign object in the wood (see ill. 15). The reaction of the chain pulls the saw forward, causing the operator to lose control.

Pull-in frequently occurs when the bumper spike of the saw is not held securely against the tree or limb and when the chain is not rotating at full speed before it contacts the wood.

### Warning!

Use extreme caution when cutting small size brush and saplings which may easily catch the chain and pull you off balance.

### To avoid pull-in

1. Always start a cut with the chain rotating at full speed and the bumper spike in contact with the wood.
2. Pull-in may also be prevented by using wedges to open the kerf or cut.

### Cutting Techniques

#### Felling

Felling is cutting down a tree.

Before felling a tree, consider carefully all conditions which may affect the direction of fall, including:

- The intended direction of the fall.
- The natural lean of the tree.
- Any unusually heavy limb structure.
- Surrounding trees and obstacles.
- The wind direction and speed.

### Warning!

Always observe the general condition of the tree. Look for decay and rot in the trunk. If it is rotted inside, it could snap and fall toward the operator while being cut.

Also look for broken or dead branches which could vibrate loose and fall on the operator. When felling on a slope, the operator should stand on the up-hill side if possible.

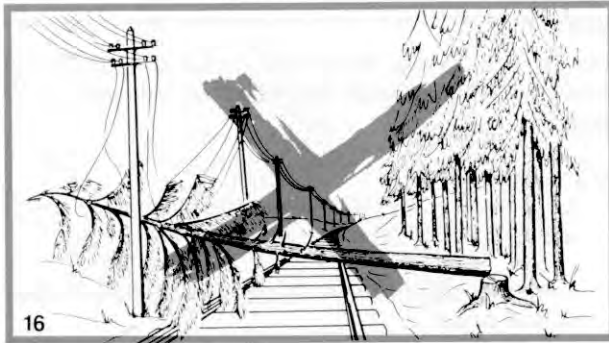

16



18

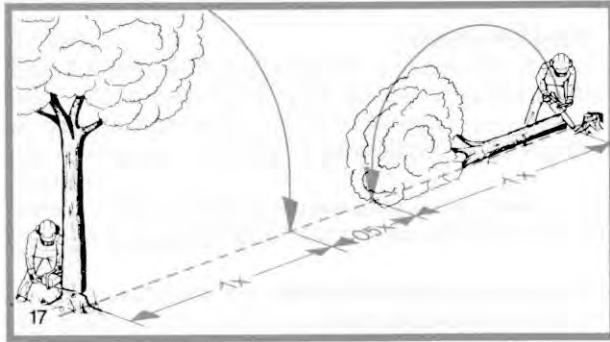

17



19

When felling in the vicinity of roads, railways and power lines, etc., take extra precautions (see ill. 16). Inform the police, utility company or railway authority before beginning to cut.

When felling, maintain a distance of at least  $2\frac{1}{2}$  tree lengths from the nearest person (see ill. 17).

**Note:**

**14** The noise of your engine may drown any warning call.

**Felling Instructions:**

First clear the tree base and work area from interfering limbs and brush and clean its lower portion with an axe (ill. 18).

Then, establish a path of escape and remove all obstacles. This path should be opposite to the planned direction of the fall of the tree and at a  $45^\circ$  angle (ill. 19). An alternate path must also be selected. Place all tools and equipment a safe distance away from the tree, but not on the escape path.





If the tree has large buttress roots, cut into the largest buttresses vertically first (horizontally next) and remove (ill. 20).

Then, determining the placement of the felling notch (ill. 21). The felling notch when properly placed determines the direction in which the tree will fall. It is made perpendicular to the line of fall and should be as close to the ground as possible. Cut the felling notch to a depth of about one-fifth to one-fourth of the trunk diameter (ill. 22). It should be in no case higher than it is deep. Make the felling notch very carefully.

Begin the felling cut slightly higher than the felling notch and on the opposite side of the tree (ill. 22). Then cut horizontally through towards the felling notch. Apply the chain saw with its spikes directly behind the uncut portion of wood and cut toward the notch (ill. 23). Leave approximately  $\frac{1}{10}$  of the tree diameter uncut. This is the hinge (ill. 23). Do not cut through the hinge because you could lose control of the direction of the fall. Drive wedges into the felling cut where necessary to control the direction of the fall. Wedges should be of wood, light alloy or plastic—never of steel, which can cause kickback and damage to the chain.

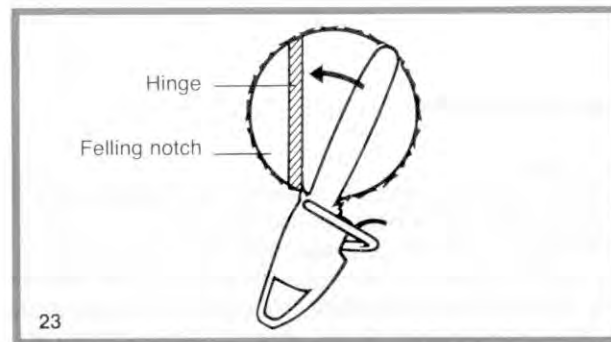
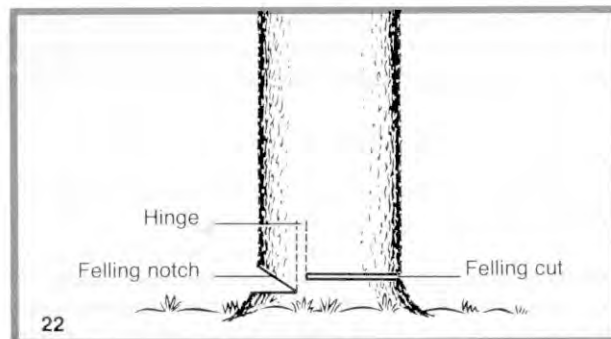
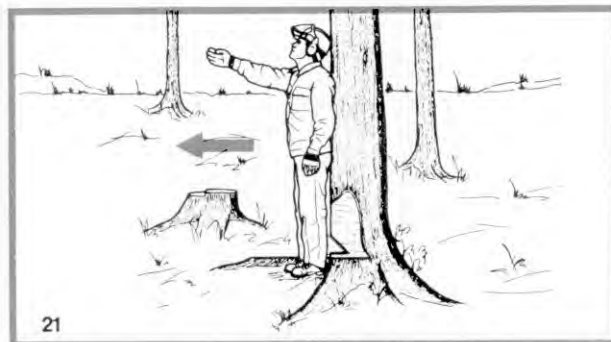

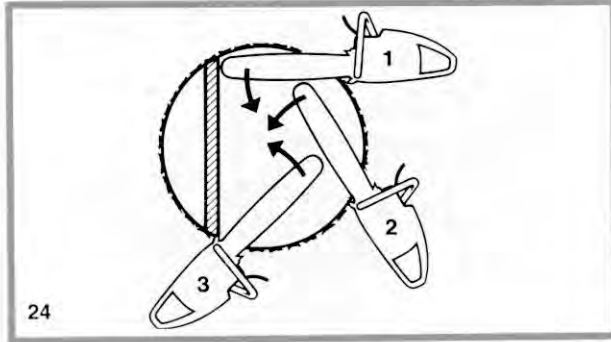

Always keep to the side of the falling tree. When the tree starts to fall, shut off the engine, withdraw the bar and walk away on the pre-planned escape path. Watch out for falling limbs.

**Warning!**

Be extremely careful with partially fallen trees which are poorly supported.

When the tree hangs or for some other reason does not fall completely, set the saw aside and pull the tree down with a cable winch, block and tackle or tractor. If you try to cut it down with your saw, you may be injured.

**Sectioning Method**

**Warning!**

Felling a tree that has a diameter greater than the length of the guide bar requires use of either the sectioning or plunge-cut method. These methods are extremely dangerous because they involve the use of the nose of the guide bar and can result in kickback. Only properly trained professionals should attempt these techniques.

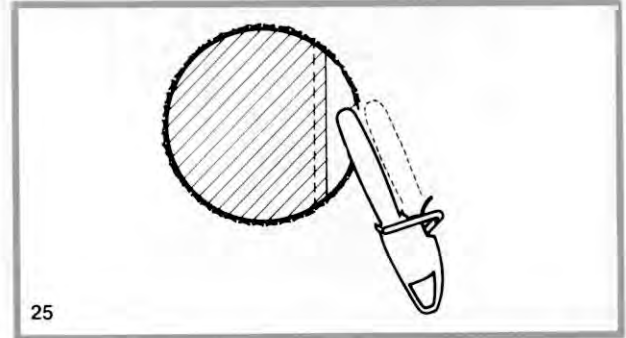

For the sectioning method (ill. 24) make the first cut with the guide bar fanning in toward the hinge. Then, using the bumper spike as a pivot, reposition the saw for the next cut. Avoid repositioning the saw more than necessary. When repositioning for the next cut, keep the guide bar fully engaged in the kerf to keep the felling cut straight. If the saw begins to pinch, insert a wedge to open the cut. On the last cut, do not cut the hinge.

**Plunge-Cut Method**

Timber having a diameter more than twice the length of the guide bar requires the use of the plunge-cut method before making the felling cut.

First, cut a large, wide notch. Make a plunge cut in the center of the notch.

The plunge cut is made with the guide bar nose. Begin the plunge cut by applying the lower portion of the guide bar nose to the tree at an angle (ill. 25). Cut until the depth of the kerf is about the same as the width of the guide bar

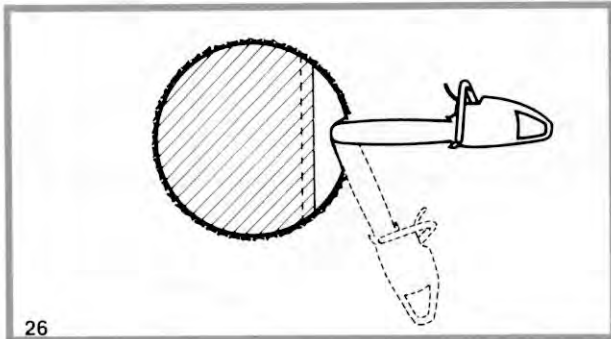

26

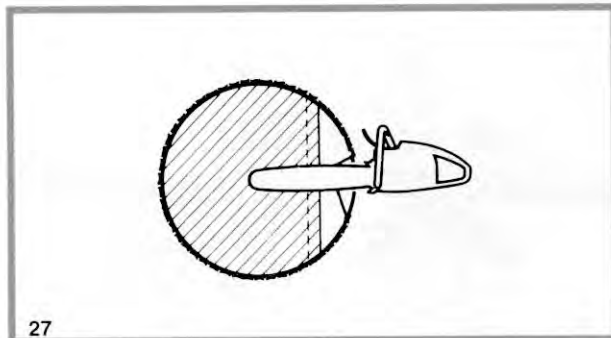

27

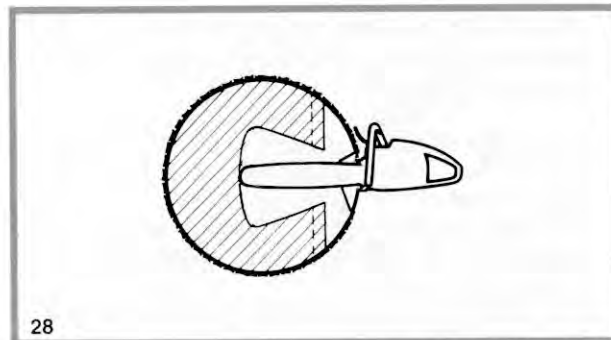

28

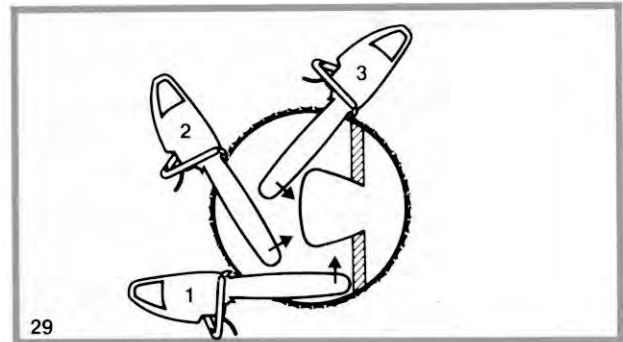

29

(ill. 26). Next, align the saw in the direction in which the recess is to be cut.

With the saw at full throttle, insert the guide bar in the trunk (ill. 27).

Enlarge the plunge cut as shown in illustration (ill. 28).

#### **Warning!**

There is an extreme danger of kickback at this point. Extra caution must be taken to maintain control of the saw. To make the felling cut, follow the sectioning method described previously (ill. 29).

If you are inexperienced with a chain saw plunge-cutting should not be attempted. Seek the help of a professional.

#### **Limbing**

Limbing is removing the branches from a fallen tree.

#### **Warning!**

There is an extreme danger of kickback during the limbing operation. Do not work with the nose of the bar. Be extremely cautious and avoid contacting the log or other limbs with the nose of the guide bar.

Do not stand on a log while limbing it – you may slip or the log may roll.



Start limbing by leaving the lower limbs to support the log off the ground (ill. 30). Always cut from the top of the limb. Do not underbuck freely hanging limbs. A pinch may result or the limb may fall, causing loss of control. If a pinch occurs, stop the engine and remove the saw, by lifting the limb.

#### Warning!

Be extremely cautious when cutting limbs under tension. The limb could spring back toward the operator and cause loss of control of the saw or injury to the operator.

#### Bucking

Bucking is cutting a log into sections.

#### Warnings!

1. When bucking, do not stand on the log. Make sure the log will not roll down-hill. If on a slope, stand on the up-hill side of the log (see ill. 31). Watch out for rolling logs.
2. Cut only one log at a time.
3. Shattered wood should be cut very carefully. Sharp splinters of wood may be caught and flung in the direction of the operator of the saw.

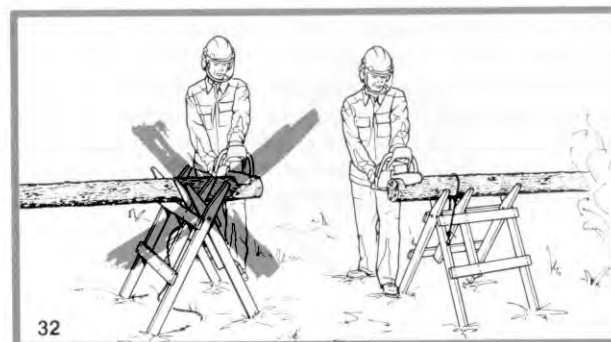

4. When cutting small logs, use a sawhorse (ill. 32). Never permit another person to hold the log. Never hold the log with your leg or foot.
5. Logs under strain require special attention to prevent the saw from pinching. The first cut is made on the compression side to relieve the stress on the log (see ill. 33, 34). The bucking cut is then made as shown. If the saw pinches, stop the engine and remove it from the log.
6. Only properly trained professionals should work in an area where the logs, limbs and roots are tangled (i.e. a

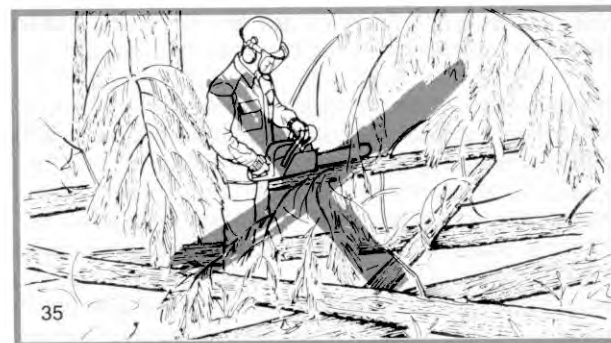
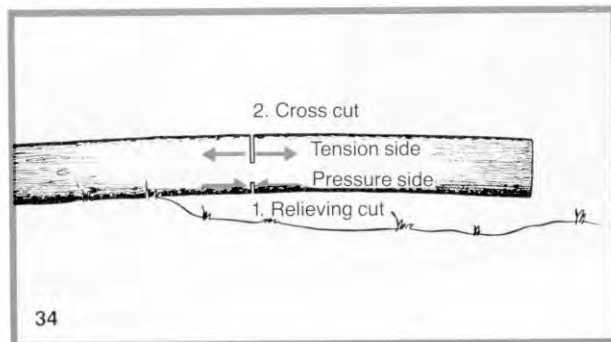
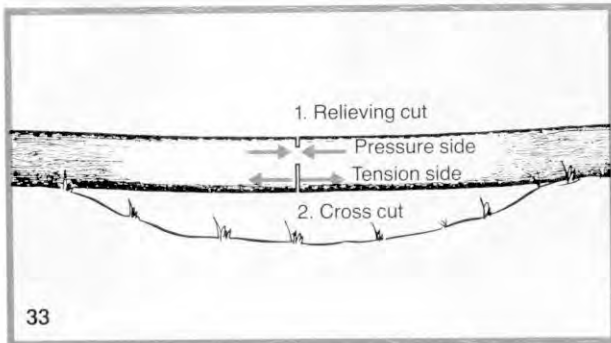

blowdown area, ill. 35). Working in blowdown areas is extremely hazardous.

7. Drag the logs into a clear area before cutting. Pull out exposed and cleared logs first.

### Maintenance and Repair

Never operate a chain saw that is damaged, improperly adjusted or not completely or securely assembled. Follow the maintenance and repair instructions in the appropriate section of your Owner's Manual.

#### Warning!

Always stop the engine and make sure that the chain is stopped before doing any maintenance or repair work or cleaning the saw. Do not attempt any maintenance or repair work not described in your Owner's Manual. Have such work performed at your STIHL service shop only.

### MAINTAINING AND STORING THE SAW

Keep the chain, bar and sprocket clean and lubricated; replace worn sprockets or chains.

Keep the chain sharp. You can spot a dull chain when easy-to-cut wood becomes hard to cut and burn marks appear on the wood.

Keep the chain at proper tension. Tighten all nuts, bolts and screws except the carburetor adjustment screws after each use.

Keep spark plug and wire connection tight and clean.

Store saws in a high or locked place, away from children.

## Fuel and Chain Lubricating Oil

The two-stroke engine is powered by a mixture of gasoline and engine oil.

**Only use regular low octane gasoline.** Never use high octane fuel as it contains benzol which will permanently damage the carburetor diaphragm.

Only use STIHL two-cycle engine oil or other branded two-stroke engine oils for mixing. The recommended mixing ratio is 1:40 (1 part oil to 40 parts regular gasoline) for STIHL two-cycle engine oil or 1:25 for other branded two-stroke engine oils.

**Important: Vigorously shake mixture in can before fueling.**

The service life of the chain and guide bar depends to a great extent on good lubrication and the quality of the lubricating oil. Never use old oil. Always use the chain lubricating oil approved by STIHL and appointed dealers.

If special chain lubricating oil is not available, one of the high-duty single-grade engine oils listed below may be used in an emergency, depending on the outside temperature.

Outside temperature + 10°C ... + 40°C: SAE 30  
Outside temperature + 10°C ... - 10°C: SAE 20  
Outside temperature - 10°C ... - 30°C: SAE 20 W  
or SAE 10 W

Always top up with chain lubricating oil when you refuel. Carefully clean the area around the filler caps before opening and make sure that no dirt falls into the tank while you are refueling.

## Mounting the Bar and Chain

Top: Setting back the tensioning nut  
Bottom: Mounting the guide bar

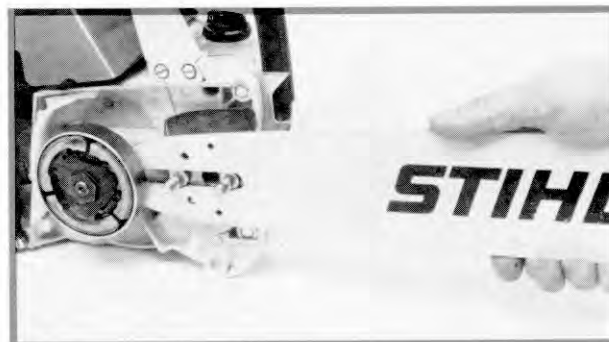
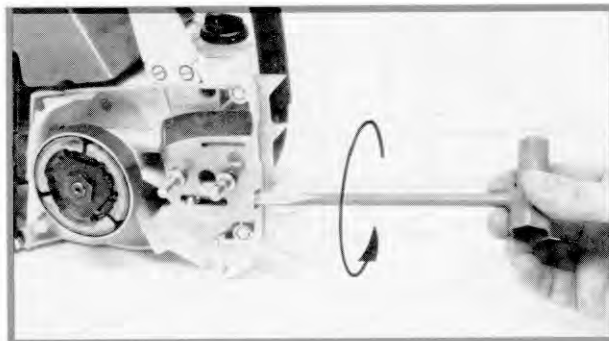

For safety reasons guide bar and saw chain are supplied separated from the saw.

For mounting first remove chain sprocket cover. To do so loosen the two collar nuts, unscrew them from the studs and remove chain sprocket cover.

Set back tensioning nut of the chain tensioning device which is positioned behind the inner side plate by turning the tensioning screw to the left — anti-clockwise — until it butts.

Top: Mounting the saw chain  
Bottom: Cutting edges pointing towards the bar head

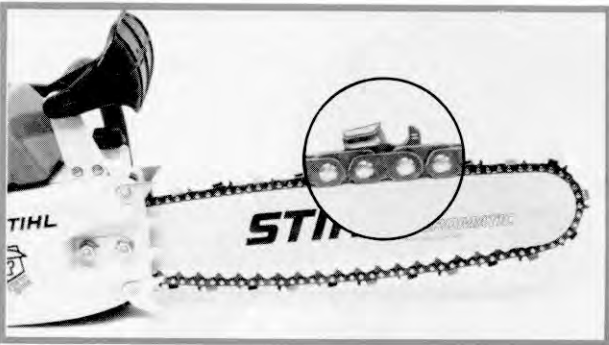

Guide the bar with the mounting slot over the bar studs in such a way that the lug of the tensioning nut engages the lower centering boring.

Put saw chain over the guide bar starting at the chain sprocket in such a way that the cutting edges of the upper chain portions point towards the guide bar head. Put chain sprocket cover again onto the bar studs, set collar nuts and tighten by hand only.

The saw chain is now tensioned by turning the tensioning screw in clockwise direction.

Top: Tensioning the saw chain  
Bottom: Checking the chain tension

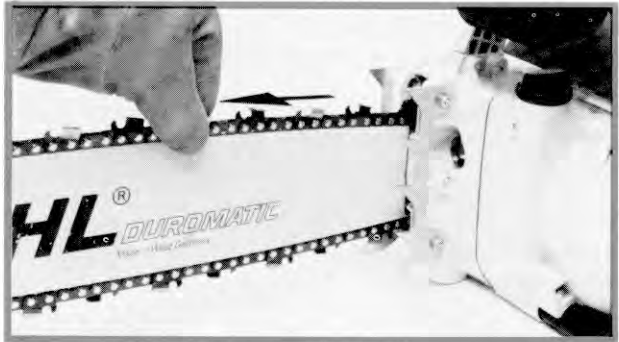
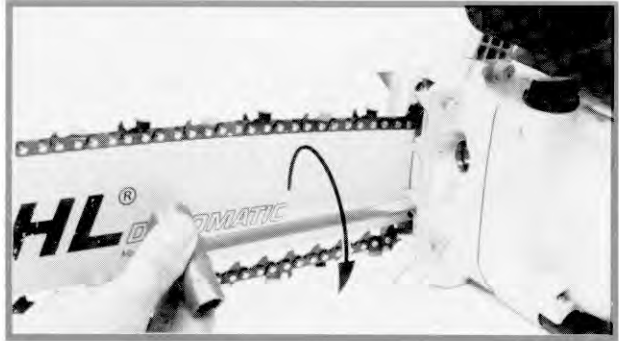

Thereby care has to be taken that the lower portion of the drive links are guided in the groove of the guide bar – bottom side. Lift guide bar at guide bar head and turn tensioning screw until the saw chain rests against the bottom side of the guide bar. Thereafter continue to lift guide bar and tension both collar nuts tightly.

The saw chain has the proper tension when it can still be pulled around the guide bar by hand.

## Starting

Ignition stop switch away from "STOP"



Start your saw without assistance of a second person. Keep other people clear of the general work area of the saw.

Place the chain saw on firm ground or other solid surface in an open area. Have a good balance and secure footing. Be absolutely sure that guide bar and chain are clear of you and all other obstruction and objects, including the ground. When engine starts (in starting-throttle position), engine speed will be fast enough for the clutch to engage sprocket and turn the chain.

### Starting procedure

1. Move stop switch (1) away from "STOP".
2. A **cold engine**, is started with the choke closed, slide choke lever (2) to "CHOKE".  
A **warm engine**, or one that has only been stopped for a brief period, is started with the choke open – slide choke lever (2) away from "CHOKE".
3. Set throttle trigger (3) to starting-throttle position: Depress at first safety throttle lock (4), then throttle trigger (3) and starting throttle lock (5). Next release throttle trigger (3) and then starting throttle lock (5).

Top: Choke lever in "Choke" position  
Center: Throttle trigger in half-throttle position  
Bottom: Starting

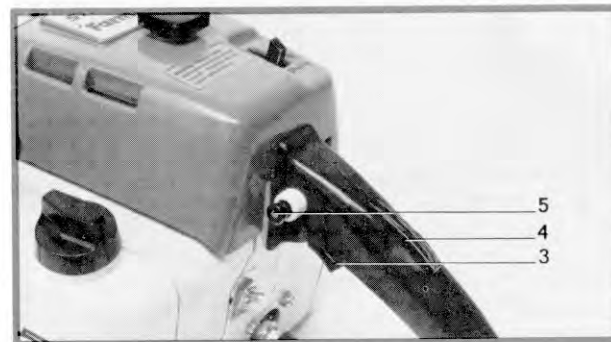



4. Hold the front handle bar with your left hand and put your right foot through rear handle (6).
5. Pull starter grip (7) slowly with your right hand until you feel the starter engage. Then make a short, quick pull. Do not allow the grip to snap back, but guide the starter rope slowly back to permit the rope to rewind properly.

Crank until the engine fires. Then open choke (choke lever away from "CHOKE", if the saw is cold) and pull again. Failure to follow this procedure may result in injury to hand or fingers and may damage the starting mechanism.

6. As soon as engine is running, depress throttle trigger momentarily to release starting throttle lock and allow the engine to run on idle speed.
7. The engine is stopped by moving the stop switch (1) to the "STOP" position.

#### Hints for starting a chain saw:

When starting a cold engine only keep the choke closed until the engine begins to fire. Then open choke fully – choke lever away from "CHOKE" – even if the engine stops and you have to repeat the starting procedure. If the choke is left closed, the combustion chamber will flood and stall the engine.

If you opened the choke after the engine fired and the engine still does not run after several attempts, it is already flooded. In such a case, remove and dry off the spark plug. Clear the combustion chamber by cranking the engine over several times on the starter with the spark plug removed.

Top: Idling position  
Bottom: Stop switch in "STOP" position



The stop switch should be off (move to "STOP") and the throttle in starting-throttle position during this process.

At very low outside temperatures do not open the choke fully after starting. First allow engine to warm up for a brief period with very little throttle (release starting throttle lock). Then release throttle trigger and open the choke.

A new engine or one which has been run until the fuel tank is dry will not start first time after refueling because the carburetor's diaphragm pump has to be primed with fuel by cranking the engine over several times on the starter.

## Cutting Attachment

- 1 Oil inlet borings
- 2 Centering borings

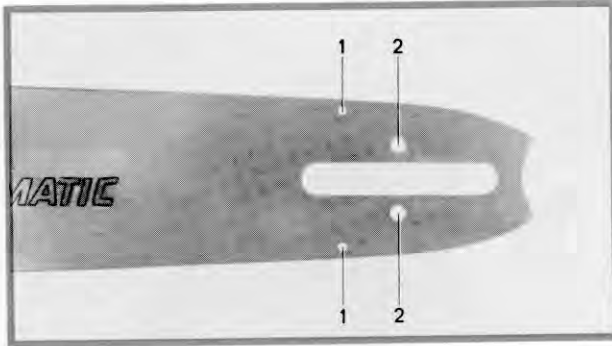

The cutting attachment of a chain saw consists of the guide bar, saw chain and chain sprocket.

### Guide bar

The nose and underside of the guide bar are subject to a particularly high rate of wear. To avoid one-sided wear, turn the bar around every time you sharpen or replace the chain. Regular cleaning of the oil inlet borings and guide bar groove is also important. The bar can be examined for signs of wear at the same time.

A minimum bar groove depth of 7 mm (0.28 in) must be maintained in order to prevent the drive links fouling the bottom of the groove (the heels of the cutter and tie strap would no longer locate on the guide bar track).

This depth should be measured at the point where the bar is stressed most, i.e. the bar nose on Duromatic bars and the area where most of the cutting is done on Rollomatic bars.

The guide bar must be replaced if the minimum depth cannot be maintained.

On Rollomatic guide bars the bearing of the nose sprocket must also be lubricated at regulated intervals with the appropriate grease gun. Lubricate at least once daily under normal operating conditions. Only use a high grade grease for refilling the grease gun, e.g. refill tube 0781 120 1111.

To lubricate, place chain saw on its side so that the bar nose is firmly supported. Clean the grease hole and pump in grease while slowly pulling saw chain around bar (sprocket rotates) so that bearing is uniformly filled. When grease emerges at the hole on the other side of the bar or around the nose sprocket, repeat the procedure on the other side.

The sprocket nose bearing should be greased more often if the cutting attachment is used in damp conditions, e.g. working in snow. After finishing cutting work the sprocket nose should be thoroughly greased from both sides to force moisture out of the bearing and prevent corrosion.

### Chain lubrication

Never operate the chain saw without proper chain lubrication. Check operation of chain lubrication and level in oil tank before starting work.

Hold chain saw with mounted cutting attachment over a light background. Take care, the Oilomatic chain must not touch the ground, i.e. keep it at least 20 cm (8 in) clear of the ground. Run the engine with half-throttle position. If an increasing patch of oil can be seen, chain lubrication is operating correctly.

#### Checking chain lubrication



#### Breaking in Oilomatic chain

Every new chain has to be broken in for about 2 to 3 minutes. Ample chain lubrication is essential during this period. After breaking in, check chain tension and adjust if necessary.

#### Correct chain tension

The Oilomatic chain must always be slackened off after finishing cutting work. A chain properly tensioned when it is warm would, when the temperature drops, be subjected to such great contraction stresses that it would break and also damage the crankshaft and bearings.

The Oilomatic chain must, therefore, always be tensioned – with the engine switched off – before you start cutting. Chain tension is correct in the cold condition when the chain fits snugly on the underside of the bar and can still be moved along the bar by hand. Extreme care must be taken as the cutting edges are very sharp.

#### Worn chain sprocket

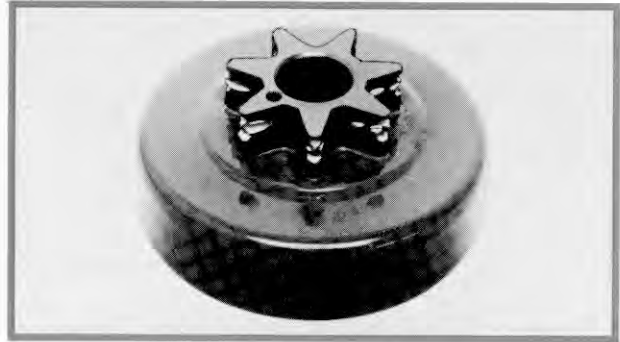

When the chain saw is operated at extremely low outside temperatures a correctly cold-tensioned Oilomatic chain will begin to sag noticeably as it warms up to normal operating temperature. The chain must then be retensioned. However, the chain must be slackened off again **immediately** after shutting down the saw. This is necessary to avoid contraction stress which would occur as the chain cools down to ambient temperature.

A new chain must be retensioned more frequently than a used one until it has stretched fully.

#### Chain sprocket

The stress and strain on the chain sprocket are particularly high. If the wear marks on the teeth are very pronounced (about 0.5 mm/0.02 in deep), the sprocket should be replaced. A worn sprocket reduces the service life of the saw chain. The chain sprocket should be replaced as a matter of routine with every second Oilomatic chain. It is best to use two saw chains alternately with one sprocket.

## Oil Quantity Control

Adjusting knob

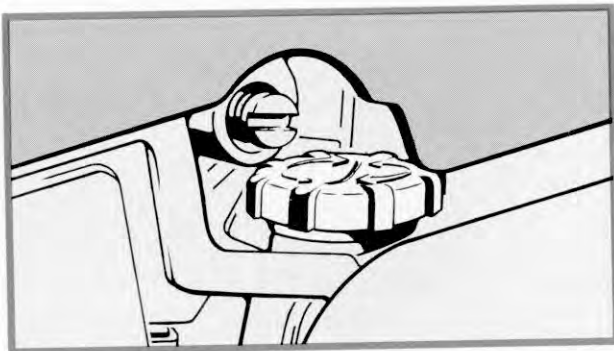

The oil quantity supply can be changed with the adjusting knob. Factory setting is made according to the cutting length of 40 cm (16 in) — 1 turn before max. position.

According to the required cutting length, kind of wood stump diameter etc. now the lubricating oil supply can be adjusted to the required cutting conditions. The adjustment is done with the adjusting knob. The knob is provided at its outer diameter with square shaped noses. The screw driver can be inserted in this noses for adjusting so that the filter cover needs not to be removed.

By turning the adjusting knob in clockwise direction (toward broad end of arrow) the lubricating quantity is increased, by turning it anti-clockwise (toward small end of arrow) the oil flow is decreased. The total adjustment scale — minimum position to maximum position — is approx. 1 $\frac{3}{4}$  turns.

## Air Filter

Disassembly of air filter; filter cover removed



Air filters have to keep back the dust of the sagged in air and therefore to reduce the wear of the driving parts.

Clogged air filters reduce the power of the engine; moreover the fuel consumption increases and makes starting more difficult.

**The air filter must be cleaned daily — at extreme dust development more often.**

Before removing close choke shutter so that no dirt can enter the carburetor. After unscrewing the filter cover the air filter can be removed. Slightly knock filter on your palm, wash in clean gasoline and shake off.

To prevent damage of the flocking do not clean the air filter with compressed air, a brush, cloth etc. A damaged air filter must be replaced.

It is advisable to always carry a spare filter with you and to clean the clogged one at home.

## Carburetor

- 1 = High speed adjustment screw H
- 2 = Low speed adjustment screw L
- 3 = Idle speed adjustment screw

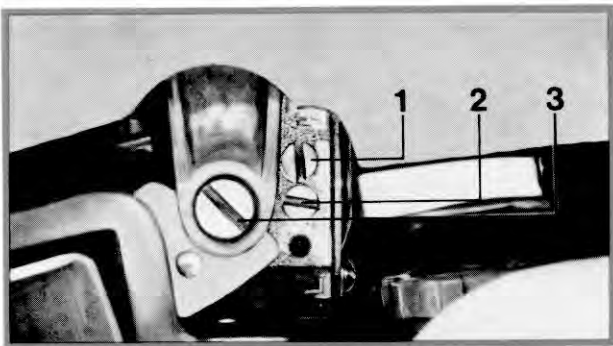

The carburetor has been adjusted at the factory for maximum performance and lowest fuel consumption under local average atmospheric conditions.

When working at high altitudes (mountains) or near sea level the carburetor must be readjusted. The adjustment must be made at the adjustment screws and at the idle speed regulating screw.

For the basic adjustment – if should be taken as a guide for all readjustments – both adjustment screws are screwed in carefully until they have a snug fit. Thereafter the following adjustments have to be made:

### High speed adjustment screw H:

Short with dull cone  
 $\frac{3}{4}$  – 1 turn open

### Low speed adjustment screw L:

Long with rounded-off point  
1 –  $1\frac{1}{4}$  turns open

Never interchange the adjustment screws!

Carburetor adjustment must only be done while engine is warm and with clean air filter.

## Notes for fine adjustment of carburetor

### Engine stops while idling:

Turn idle speed adjustment screw slightly clockwise while the engine is running (chain must not turn).

### Chain turns while engine is idling:

Turn idle speed adjustment screw slightly counterclockwise.

### Engine runs erratically at idle speed:

Adjust at low speed adjustment screw. Turn clockwise for leaner mixture or counter-clockwise for richer mixture.

**Caution:** The setting of the high-speed adjustment screw affects the engine's maximum off-load speed. If it is set too lean (adjustment screw turned too far clockwise), the maximum permissible engine speed of 10000 r.p.m. will be exceeded. This can result in engine damage brought about by insufficient lubrication in particular.

Apart from minor readjustments, you should not attempt carburetor adjustments or repairs yourself. Entrust such work to STHIL Service. In most areas you will find STIHL Service Shops with trained specialists and the tools necessary for expert servicing.

## Rewind Starter

Remove the mounting screws

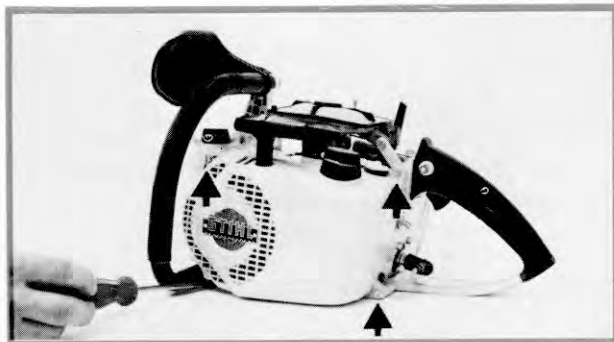

### Replacing a broken starter rope

First remove the filter cover and disconnect fuel line from elbow connector. Thereafter unscrew the 4 cyl. head screws M 5 with which the fan housing is fastened. Now the complete fan housing can be removed.

Using a screwdriver, or a suitable pair of pliers, carefully remove the spring clip from the starter post groove. The rope rotor, together with the pawl can now be lifted off.

Remove any remaining rope from the rope groove in the rotor. Thread in a new starter rope, 4.5 mm (0.18 in) diameter and 1000 mm (40 in) long and secure it to the rope rotor with a simple overhand knot. Seal the ends of the rope to prevent ravelling with a match or lighter flame. Thread the other end of the rope through the rope guide hole in the fan housing from inside, pass it through the starter grip in an upward direction and secure it with a figure 8 or looped overhand knot (see diagram of knots).

Do not rewind the rope on the rotor at this time.

Clean and lubricate the rope rotor's bushing with a non-resinous oil, slide the rotor on the starter axle or post and align the rewind spring anchor loop (exposed through the

Top: Possible special knots  
Bottom: Component parts of the starter assembly

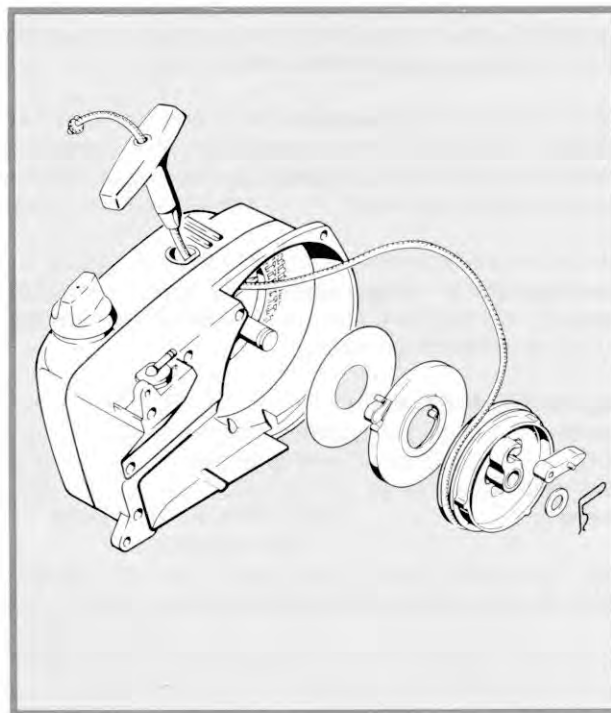
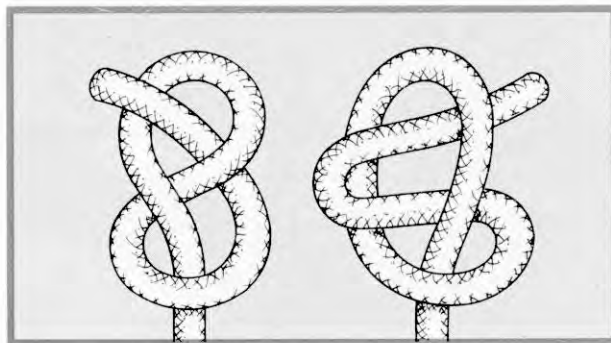

Installing the spring clip



center opening in the rewind spring housing) with the notched section of the rib on the back of the rope rotor. Rotate the rotor back and forth until the slotted area engages the starter rewind spring anchor loop.

Now insert pawl in rope rotor and press spring clip onto starter post with a suitable pair of pliers, making sure that the spring clip engages on the pawl's guide pin and points it in the clockwise direction. Then tension rewind spring.

### Replacing a broken rewind spring

Remove the rope rotor as above. The spring housing together with the rewind spring can then be removed from the fan housing by turning the fan housing over and let it drop out of the recess in the fan housing. A replacement spring and spring housing are supplied as an assembly. Lubricate the spring with a few drops of non-resinous oil before installing it.

Drop the rewind spring/housing assembly (with the bottom plate area up) into the fan shroud recess. If the spring should pop out of its housing during installation re-insert it in its housing starting from outside to inside in counter-clockwise direction. Reassemble the rope rotor as above.

Tensioning the rewind spring



### Tensioning the rewind spring

Rewind the starter rope by turning the rotor in counter-clockwise direction until the starter grip has reached a distance of about 20 cm (8 in) from the fan shroud. Form a loop in the remaining rope next to the rim of the rope rotor. Use this loop to turn the rope rotor clockwise by three full revolutions and hold the rope rotor in place by hand. Pull out and straighten the twisted rope. Gradually release the rope rotor and pull in the starter rope until it is fully rewound on the rope rotor by spring force.

The rewind spring is tensioned correctly if the starter grip is held firmly in place against the starter housing by spring tension and does not droop. If more tension is required add one more turn on the rope rotor. The rope rotor should be able to be rotated by at least one-half an extra turn with the rope pulled all the way out. If spring tension is too great pull out the starter rope, hold the rotor firmly by hand, and remove one turn of the rope.

**A starter spring that is tensioned too heavily will probably break.**

Re-install the fan shroud with the retaining screws securely tightened.

## Replacing the Chain Sprocket

First remove chain sprocket cover and bar and chain. Thereafter loosen and unscrew spark plug with combination wrench.

Screw stop screw into the cylinder by hand until it has a snug fit. Turn crankshaft in clockwise direction until the piston rests against the locking screws thus locking the crankshaft. Now loosen clutch carrier with combination wrench.

**Attention! The thread of the clutch carrier is a left hand thread — loosen in clockwise direction!**

After removing the clutch the guide washer, chain sprocket, spacer ring, needle cage and cover plate can be removed from the crankshaft.

Clean crankshaft end, wash needle cage in clean gasoline and apply ball bearing grease.

Mounting of the new chain sprocket is done in reverse sequence. Before putting on the cover plate check the pressed-in cylindrical pin for proper condition. If it is damaged or broken insert a new one. Moreover, care has to be taken that the cylindrical pin engages into the boring of the worm gear and on the other end the cylindrical pin engages the boring provided in the chain sprocket.

If the clutch is mounted onto the crankshaft tighten the carrier with a torque of 40 Nm (29 lbf. ft). This is done best with a torque wrench.

Finally turn out stop screw, screw in and tighten spark plug again.

Top: Component parts in correct sequence  
Center: Tightening the carrier with the combination wrench  
Bottom: Tightening the carrier with the torque wrench

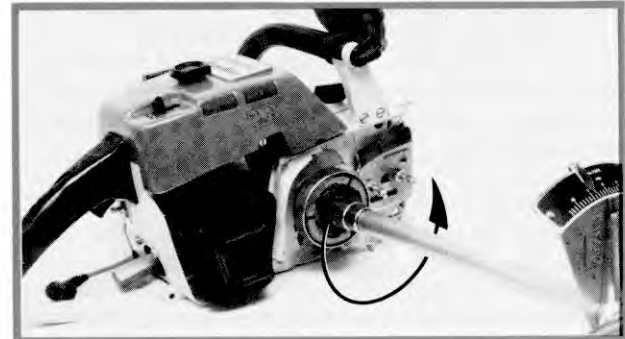
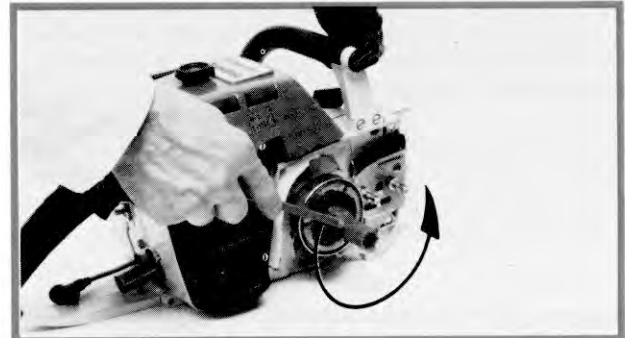
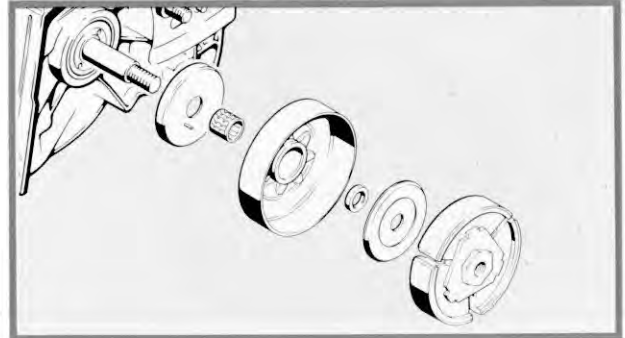



# Maintenance Chart

		before starting work	after finishing work or daily	after each refueling stop	weekly	monthly	if faulty	if damaged	as required	see page:
Complete machine	Visual inspection (condition, leaks)	×		×						
	clean		×							
Throttle trigger, safety throttle lock, stop switch	Check operation	×		×						
Chain brake	Check operation									
	Clean									
Filter in fuel tank	Clean wire filter					×				
	Replace felt									
Fuel tank	Clean					×				
Chain oil tank	Clean					×				
Chain lubrication	Check	×								24, 26
Saw chain	Inspect, also check sharpness	×		×						
	Check chain tension	×		×						25
	Sharpen								×	33
Guide bar	Inspect (wear, damage)	×								24
	Clean and turn over				×					
	Lubricate sprocket nose		×							24
	Deburr				×					
	Replace							×	×	
Chain sprocket	Check				×					25
Air filter	Clean	×					×			26
	Replace							×		26
Cooling inlets	Clean		×							
Cylinder fins	Clean					×				
Carburetor	Check idle adjustment – chain must not turn	×		×						27
	Readjust idle								×	27
Spark plug	Readjust electrode gap						×			
All accessible screws and nuts (not adjusting screws)	Retighten								×	
Rubber vibration buffers	Inspect									
	To be replaced only by STIHL Dealer									
Spark arrestor screen	Inspect	×								
	Clean or replace							×		
Chain catching bolt	Check	×								
	Replace							×		

## Specifications

### Engine

STIHL-single-cylinder, two-cycle engine  
Piston displacement: 61 cm<sup>3</sup> (3.72 cu.in)  
Cylinder bore: 44 mm (1.73 in)  
Piston stroke: 40 mm (1.57 in)

### Ignition System

Principle: magneto with breaker points  
Ignition timing: 2,4 . . . 2,6 mm (0.09 . . . 0.1 in)  
before top dead center  
Breaker point gap: 0,3 . . . 0,4 mm  
(0.012 . . . 0.016 in)  
Spark plug (inter-  
ference suppressed): Bosch WSR 6 F or  
Champion RCJ 6 Y,  
Heat value 175  
Electrode gap 0,5 mm  
(0.02 in)  
Spark plug thread: M 14 x 1,25; 9,5 mm  
(0.37 in) long

### Fuel System

Carburetor: All position diaphragm  
carburetor with integral  
fuel pump  
Air filter: Flocked wire mesh filter  
Fuel tank capacity: 0,62l (1,31 pt)  
Fuel mixture: Mixing ratio 1:40 for STIHL  
two-stroke engine oil; 1:25  
for other good-grade two-  
stroke engine oils

### Cutting Attachment

Guide bars: Duromatic guide bars with  
stellite tipping at the bar nose  
Rollomatic guide bars with  
star shaped roller nose  
Bar lengths: Duromatic 40; 45; 50 and 63 cm  
(16; 18; 20 and 25 in)  
Rollomatic 37; 40; 45;  
50 and 63 cm  
(15, 16; 18; 20 and 25 in)  
Oilomatic chain:  $\frac{3}{8}$ " (9,32 mm)-Rapid-  
Standard, -Rapid-Micro  
and -Rapid-Super.  
Rapid-Standard- and  
Rapid-Micro-chain also  
available in S-type  
execution  
Chain sprocket: 7 teeth for  $\frac{3}{8}$ " pitch  
Chain lubrication: Fully automatic oil pump  
adjustable oil quantity control  
Oil tank capacity: 0,25 l (0.53 pt)

### Weight

with 37 cm (15 in)  
bar and chain: 7,4 kg (16.3 lb)

## Sharpening and Maintenance of Saw Chain

### Description of chains

STIHL saw chains are 3-link chains and all versions are assembled in the same basic pattern. The illustration on the right shows the component parts of a saw chain. Every chain manufactured by STIHL features the exclusive Oilomatic system. Apart from the three basic types (Rapid, Picco and Topic), there are three different versions whose names denote the cutter shape, i. e. chipper tooth = Standard, semi-chisel = Micro and full chisel = Super. Oilomatic Rapid chains are also available in standard and safety versions.

The main size measurement on a saw chain is the pitch. It is determined by measuring the distance from any three rivets in line and divided by two. The result is the pitch which, in accordance with international custom, is specified in inch ( $\frac{3}{8}'' = 9.32 \text{ mm}$ ).

Like any other cutting tool, the saw chain is subject to normal wear. A properly sharpened chain will cut into the wood and require very little effort on the part of the operator. For this reason alone you should never attempt to cut with a dull or damaged chain.

There are a few crucial angles which must be maintained in order to obtain good results when sharpening a chain. They are explained below.

### Filing angle

The filing angle for Rapid-Standard and Rapid-Micro chains is  $35^\circ$ ; these chains are initially sharpened to this angle before leaving the factory. However, if the chain is used primarily for cutting hardwood or frozen timber it is best to sharpen it to an angle of  $30^\circ$ . On the other hand, the filing angle for Rapid-Super and Topic-Super is always  $30^\circ$ .

Top: Component parts of Oilomatic Rapid chain  
Bottom: Measuring chain pitch

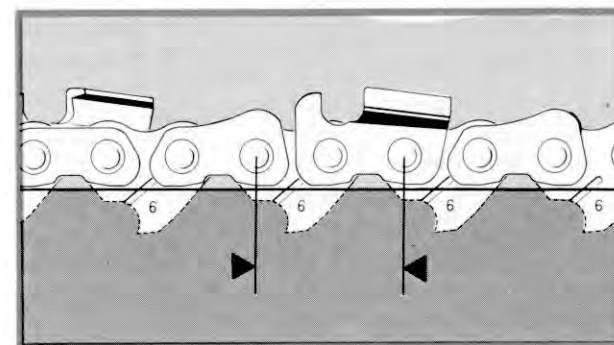
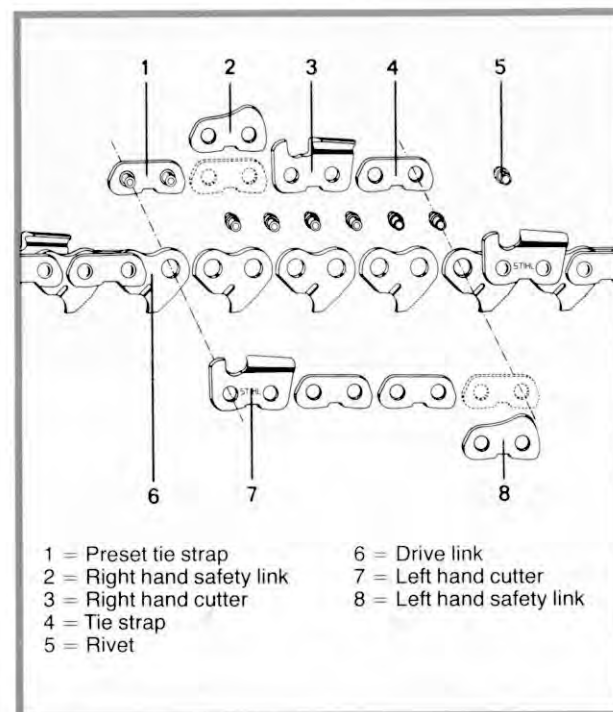

Top: Filing angle  
 Center: Side plate angle  
 Bottom: Table of file diameters

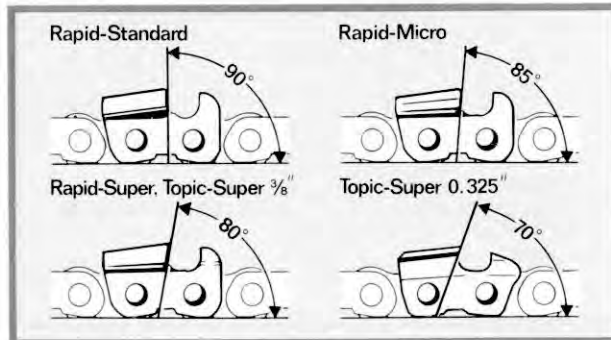
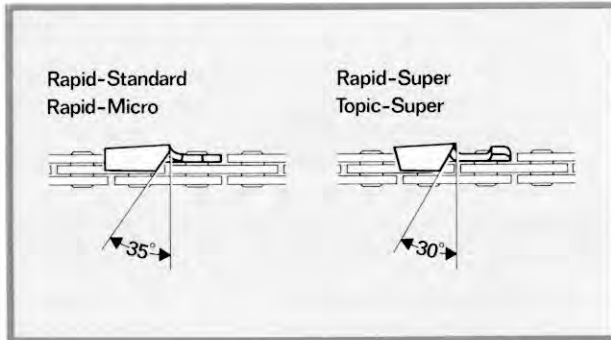

Chain pitch	File dia.	File No.
.325" (8.25 mm)	4.8 mm	0811 411 8088
.325" (Topic)	4.0 mm	0814 242 3383
$\frac{3}{8}$ " (9.32 mm)*	5.5 mm	0811 411 8108
$\frac{3}{8}$ " (Topic)	4.5 mm	6814 242 3396
.404" (10.26 mm)*	5.5 mm	0811 411 8108
$\frac{1}{2}$ " (12.7 mm)	6.3 mm	0811 411 8118

\* Rapid-Standard and -Micro: Use 4.8 mm dia. file when cutter has been filed back half-way.

It is essential to insure that the filing angle is kept exactly the same on all cutters. Irregular angles will cause the chain to run roughly and unevenly as well as increase the rate of wear and result in chain breakage. When sharpening by hand **always file from the inside to the outside of the cutting edge.**

### Side plate angle

The upright cutting edge just below the top plate is known as the side plate cutting edge. The side plate angle is, therefore, the angle between the side plate cutting edge and the horizontal line formed by the cutter toe and heel. The specified side plate angles are  $90^\circ$  for Rapid-Standard,  $85^\circ$  for Rapid-Micro and  $70^\circ$  respectively and  $80^\circ$  for Rapid-Super and Topic-Super chain. These angles are obtained automatically if a file holder is used with the correct file and the file is held correctly during sharpening.

### Top plate cutting angle

The top plate cutting angle is  $60^\circ$  on all chains. It is also obtained automatically when the chain is sharpened carefully with a file holder or another STIHL sharpening tool.

### Sharpening

Only special saw chain files may be used for sharpening and they must match the chain pitch. The shape and cut of machinists' files makes them unsuitable for saw chain. The special chain file should be used with a file holder or a filing tool.

All cutters must be filed to the same length. As the top plate slopes downward to the rear (clearance angle) the cutter

Top: File position for Rapid-Standard  
Bottom: Sharpening with file holder

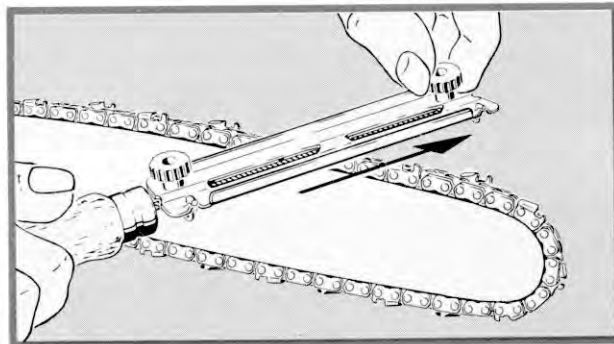
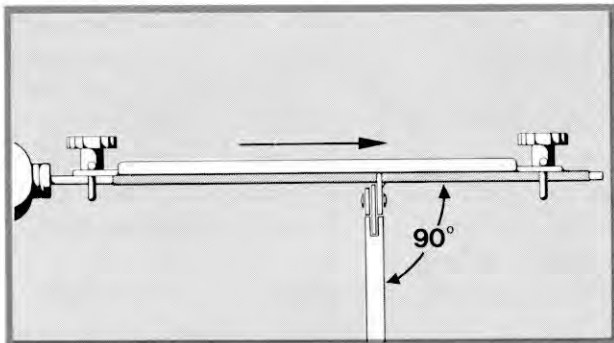

heights will be uneven if the cutter lengths are different. If the cutters are not all the same height the chain will run roughly and eventually break.

As it is very important to achieve uniform cutter lengths it is best to measure them with a slide caliper. Find and sharpen the shortest cutter first and then use it as a master for all the others, i.e. all cutters must be filed back to the same length as the master cutter. Sharpen all the cutters on one side of the chain first and then repeat the procedure on the other side.

File position for Rapid-Micro, Rapid-Super and Topic-Super

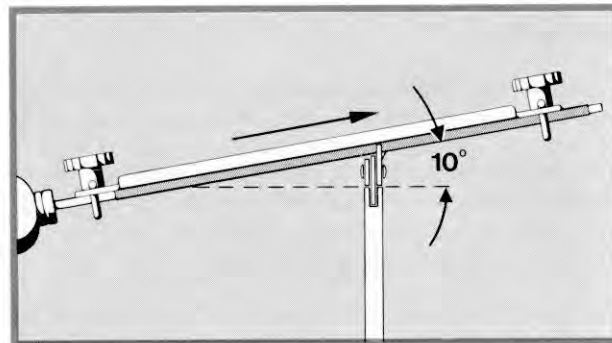

The file must be held level for **Rapid-Standard chain** so that it is at 90° to the perpendicular faces of the chain links.

On **Rapid-Micro, Rapid-Super and Topic-Super chains** the file and file holder must be guided so that the handle is 10° lower than the tip of the file, i.e. in this case the file must run upward at an angle of 10° to the horizontal. A file holder must always be used for manual sharpening of Rapid-Super and Topic-Super chains.

File evenly and steadily and note that the file **only sharpens on the forward stroke**. The file must be lifted off the cutter on the backstroke. Make sure that you do not touch the tie straps and drive links. Burrs on the cutting edge can be removed with a piece of hardwood.

Rotate the file at frequent intervals in order to prevent it becoming worn unevenly.

**Important:** Sharpen the chain frequently and take away as little material as possible. Two or three strokes of the file are usually sufficient to keep the chain sharp.

A STIHL electric sharpener greatly simplifies chain sharpening.

## Depth gauges

The depth gauge determines the height at which the cutter enters the wood and thus the thickness of the chip removed. The cutting capacity and life of a saw chain are therefore influenced by the distance between the depth gauge and the cutting edge, i. e. the depth gauge setting. This setting varies according to chain pitch and must be checked with the appropriate filing gauge.

The best cutting results are obtained with the settings listed in the table on the right. However, the depth gauge setting may be increased by 0.2 mm for cutting softwood in mild weather conditions.

As the cutter is sharpened the depth gauge setting is reduced. This means the height of the depth gauge must be checked and lowered if necessary. If the depth gauge projects from the filing gauge, it must be filed down level with the gauge. All depth gauges should be rounded off to its original shape.

## General chain maintenance

Chain maintenance begins as soon as the chain is fitted on the bar and sprocket. The essential points are **correct chain tension and ample lubrication**. See also "Cutting Attachment".

Clean the chain thoroughly in gasoline after sharpening in order to remove filings or grinding dust. Then lubricate the chain by immersing it in an oil bath. If the chain has not been used for an extended period, clean it with a brush and immerse it in an oil-paraffin bath.

Top: Table of recommended depth gauge settings  
Center: Depth gauge setting  
Bottom: Filing down depth gauge (Rapid chain)

Chain pitch	Setting	Filing gauge
.325" (8.25 mm)	0.65 mm	1110 893 4000
$\frac{3}{8}$ " (9.32 mm)	0.65 mm	1110 893 4000
.404" (10.26 mm)	0.8 mm	1106 893 4000
$\frac{1}{2}$ " (12.7 mm)	0.8 mm	1106 893 4000
090 G chain saw		
$\frac{1}{2}$ " (12.7 mm)	1.2 mm	1106 893 4010

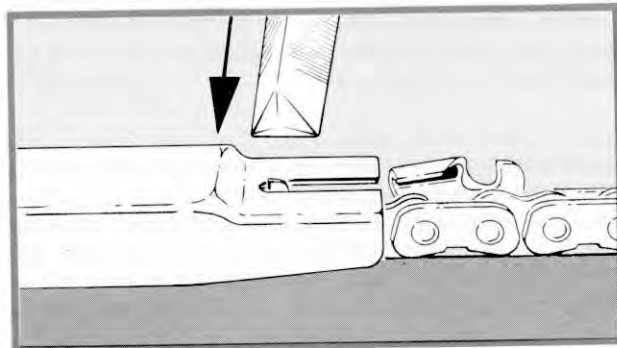
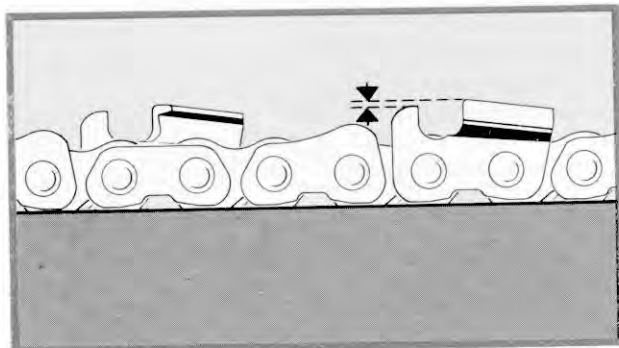

Carefully examine chain for cracks in the links or damaged rivets while you are sharpening and cleaning it. Any damaged or worn parts must be replaced. The new parts must be reworked to match the shape and size of the original parts.

Chain breaking and riveting is best carried out with the STIHL rivet spinner.

### Tools for chain maintenance

The **filing grid** has reference marks for the filing angle and is attached to the guide bar by means of a magnet.

**File holders**, which also have reference marks for the filing angle, simplify chain sharpening.

If you use the **STIHL-“Feilgenau”**, the **STIHL HOS** and **USG electric sharpeners** or the **STIHL rivet spinner**, always follow the separate operating instructions supplied with the tool.

Top: Table of file holder order numbers  
Bottom: STIHL file holder

Chain pitch	Chain	File holder
.325" (8.25 mm)	Rapid-Micro	5605 750 4325
.325" (8.25 mm)	Rapid-Super	5605 750 4340
3/8" (9.32 mm)	Rapid-Standard	5605 750 4330
3/8" (9.32 mm)	Rapid-Micro	5605 750 4330
3/8" (9.32 mm)	Rapid-Super	5605 750 4335
3/8" (9.32 mm)	Topic-Super	5605 750 4345
.404" (10.26 mm)	Rapid-Standard	5605 750 4330
.404" (10.26 mm)	Rapid-Micro	5605 750 4330
.404" (10.26 mm)	Rapid-Super	5605 750 4335

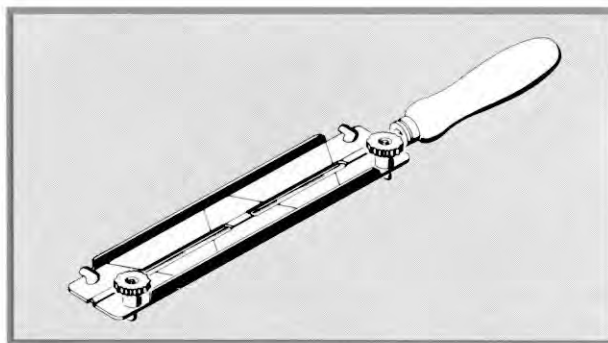

- 1 = for Micro and Picco
- 2 = for Standard
- 3 = for Super
- 4 = Standard, Micro and Picco filing angle

- 5 = Super filing angle
- 6 = Depth gauge setting
- 7 = Groove cleaner and scale for groove depth

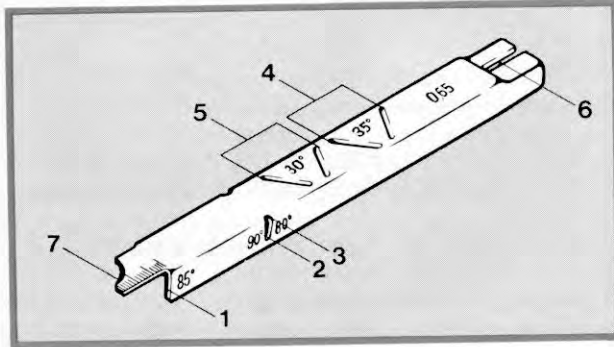

The **filing gauge** is a universal tool for checking the filing and side plate angles as well as the depth gauge setting and cutter length. It can also be used for cleaning the groove and oil inlet hole on the guide bar and measuring the groove depth.

- 1 = Sprocket pitch
- 2 = Chain pitch
- 3 = Drive link gauge
- 4 = Groove width

- 5 = Lug for cleaning bar groove and oil inlet hole

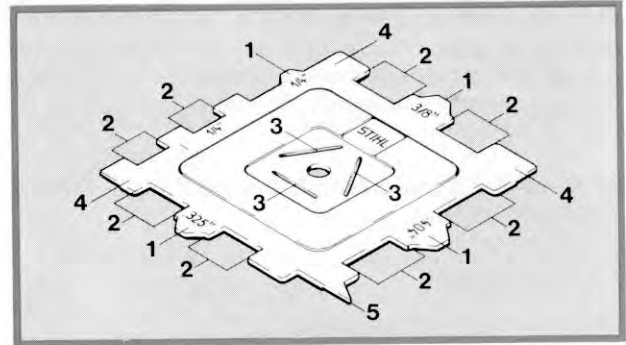

The **reference gauge 0000 893 4105** is used for measuring the pitch of the chain and sprocket as well as the drive link gauge on any chain. It is also provided with a lug for cleaning the bar groove and oil inlet hole.



## Continuation of Important Safety Precautions

14. Keep the handles dry, clean and free of oil or fuel mixture.
15. Operate the chain saw only in well ventilated areas.
16. Do not operate a chain saw in a tree unless specifically trained to do so.
17. **All** chain saw service, other than the items listed in the Owner's Manual maintenance instructions, should be performed by competent chain saw service personnel. (E.g., if improper tools are used to remove the flywheel, or if an improper tool is used to hold the flywheel in order to remove the clutch, structural damage to the flywheel could occur which could subsequently cause the flywheel to burst).
18. Avoid kickback. Kickback is the upward motion of the guide bar which occurs when the saw chain at the nose of the guide bar contacts an object. Kickback can lead to dangerous loss of control of the chain saw.

### **To avoid kickback:**

- Hold the chain saw firmly with both hands.
  - Don't overreach.
  - Don't let the nose of the guide bar contact a log, branch, ground or any other obstruction.
  - Cut at high engine speeds.
  - Don't cut above shoulder height.
  - Follow manufacturer's sharpening and maintenance instructions for the saw chain.
  - Use devices such as low kickback chain, which may help to reduce the hazards associated with kickback.
19. When transporting your chain saw, use the appropriate guide bar scabbard.
  20. Narrow nose bars and low kickback chains are designed to reduce the risk of kickback injury. Ask your dealer about these devices.

englisch/english